

- 8 A RMS
- Glass Passivated Wafer
- 400 V to 800 V Off-State Voltage
- Max I_{GT} of 50 mA (Quadrants 1 - 3)

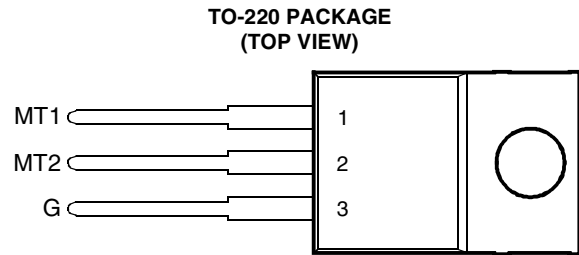

Pin 2 is in electrical contact with the mounting base.

MDC2ACA

absolute maximum ratings over operating case temperature (unless otherwise noted)

RATING		SYMBOL	VALUE	UNIT
Repetitive peak off-state voltage (see Note 1)	TIC226D	V_{DRM}	400	V
	TIC226M		600	
	TIC226S		700	
	TIC226N		800	
Full-cycle RMS on-state current at (or below) 85°C case temperature (see Note 2)		$I_{T(RMS)}$	8	A
Peak on-state surge current full-sine-wave at (or below) 25°C case temperature (see Note 3)		I_{TSM}	70	A
Peak gate current		I_{GM}	±1	A
Peak gate power dissipation at (or below) 85°C case temperature (pulse width ≤ 200 μs)		P_{GM}	2.2	W
Average gate power dissipation at (or below) 85°C case temperature (see Note 4)		$P_{G(AV)}$	0.9	W
Operating case temperature range		T_C	-40 to +110	°C
Storage temperature range		T_{stg}	-40 to +125	°C
Lead temperature 1.6 mm from case for 10 seconds		T_L	230	°C

- NOTES: 1. These values apply bidirectionally for any value of resistance between the gate and Main Terminal 1.
 2. This value applies for 50-Hz full-sine-wave operation with resistive load. Above 85°C derate linearly to 110°C case temperature at the rate of 320 mA/°C.
 3. This value applies for one 50-Hz full-sine-wave when the device is operating at (or below) the rated value of on-state current. Surge may be repeated after the device has returned to original thermal equilibrium. During the surge, gate control may be lost.
 4. This value applies for a maximum averaging time of 20 ms.

electrical characteristics at 25°C case temperature (unless otherwise noted)

PARAMETER	TEST CONDITIONS			MIN	TYP	MAX	UNIT
I_{DRM} Repetitive peak off-state current	$V_D = \text{rated } V_{DRM}$	$I_G = 0$	$T_C = 110^\circ\text{C}$			±2	mA
I_{GT} Gate trigger current	$V_{supply} = +12 \text{ V}^\dagger$	$R_L = 10 \Omega$	$t_{p(g)} > 20 \mu\text{s}$		6	50	mA
	$V_{supply} = +12 \text{ V}^\dagger$	$R_L = 10 \Omega$	$t_{p(g)} > 20 \mu\text{s}$		-12	-50	
	$V_{supply} = -12 \text{ V}^\dagger$	$R_L = 10 \Omega$	$t_{p(g)} > 20 \mu\text{s}$		-10	-50	
	$V_{supply} = -12 \text{ V}^\dagger$	$R_L = 10 \Omega$	$t_{p(g)} > 20 \mu\text{s}$		25		
V_{GT} Gate trigger voltage	$V_{supply} = +12 \text{ V}^\dagger$	$R_L = 10 \Omega$	$t_{p(g)} > 20 \mu\text{s}$		0.7	2	V
	$V_{supply} = +12 \text{ V}^\dagger$	$R_L = 10 \Omega$	$t_{p(g)} > 20 \mu\text{s}$		-0.8	-2	
	$V_{supply} = -12 \text{ V}^\dagger$	$R_L = 10 \Omega$	$t_{p(g)} > 20 \mu\text{s}$		-0.8	-2	
	$V_{supply} = -12 \text{ V}^\dagger$	$R_L = 10 \Omega$	$t_{p(g)} > 20 \mu\text{s}$		0.9	2	
V_T On-state voltage	$I_T = \pm 12 \text{ A}$	$I_G = 50 \text{ mA}$	(see Note 5)		±1.5	±2.1	V

† All voltages are with respect to Main Terminal 1.

PRODUCT INFORMATION

APRIL 1971 - REVISED SEPTEMBER 2002
 Specifications are subject to change without notice.

electrical characteristics at 25°C case temperature (unless otherwise noted) (continued)

PARAMETER	TEST CONDITIONS			MIN	TYP	MAX	UNIT
I_H Holding current	$V_{supply} = +12 V \uparrow$ $V_{supply} = -12 V \uparrow$	$I_G = 0$ $I_G = 0$	Init' $I_{TM} = 100 mA$ Init' $I_{TM} = -100 mA$		10 -6	30 -30	mA
I_L Latching current	$V_{supply} = +12 V \uparrow$ $V_{supply} = -12 V \uparrow$	(see Note 6)				50 -50	mA
dv/dt Critical rate of rise of off-state voltage	$V_{DRM} = \text{Rated } V_{DRM}$	$I_G = 0$	$T_C = 110^\circ C$		± 100		V/ μs
dv/dt _(c) Critical rise of commutation voltage	$V_{DRM} = \text{Rated } V_{DRM}$	$I_{TRM} = \pm 12 A$	$T_C = 85^\circ C$ (see figure 7)	± 5			V/ μs

† All voltages are with respect to Main Terminal 1.

NOTES: 5. This parameter must be measured using pulse techniques, $t_p \leq 1 ms$, duty cycle $\leq 2 \%$. Voltage-sensing contacts separate from the current carrying contacts are located within 3.2 mm from the device body.

6. The triacs are triggered by a 15-V (open-circuit amplitude) pulse supplied by a generator with the following characteristics:
 $R_G = 100 \Omega$, $t_{p(g)} = 20 \mu s$, $t_r \leq 15 ns$, $f = 1 kHz$.

thermal characteristics

PARAMETER	MIN	TYP	MAX	UNIT
$R_{\theta JC}$ Junction to case thermal resistance			1.8	$^\circ C/W$
$R_{\theta JA}$ Junction to free air thermal resistance			62.5	$^\circ C/W$

TYPICAL CHARACTERISTICS

GATE TRIGGER CURRENT
vs

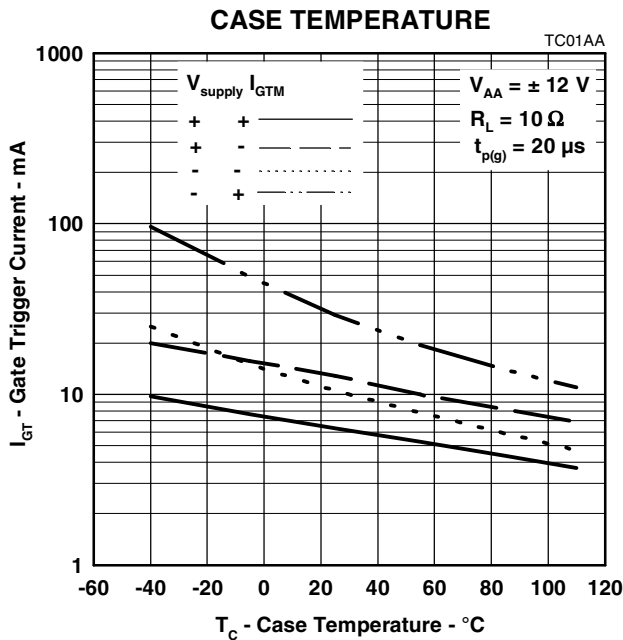

Figure 1.

GATE TRIGGER VOLTAGE
vs

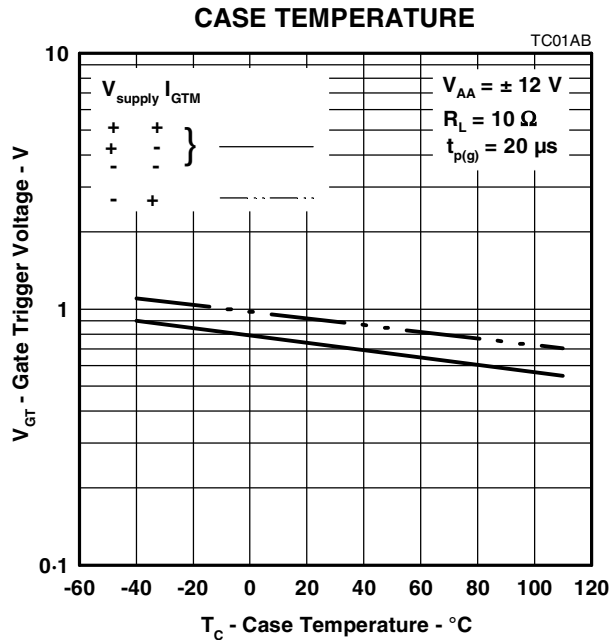

Figure 2.

PRODUCT INFORMATION

TYPICAL CHARACTERISTICS

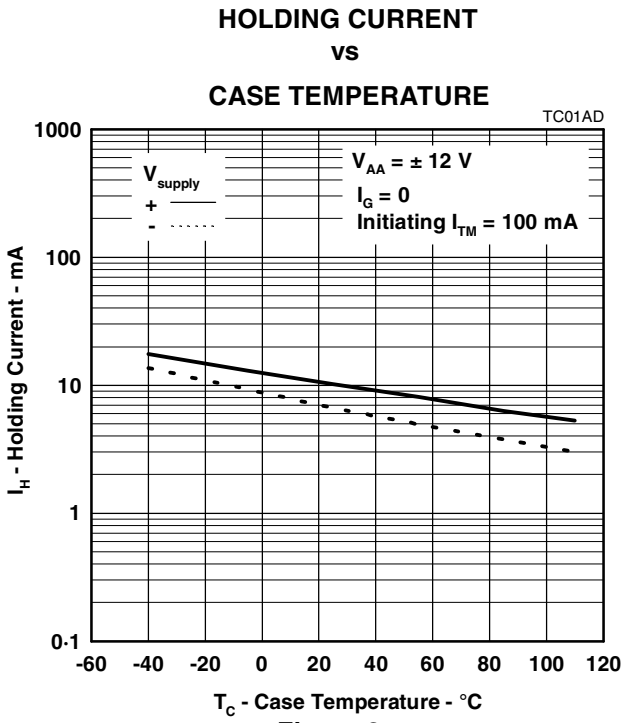

Figure 3.

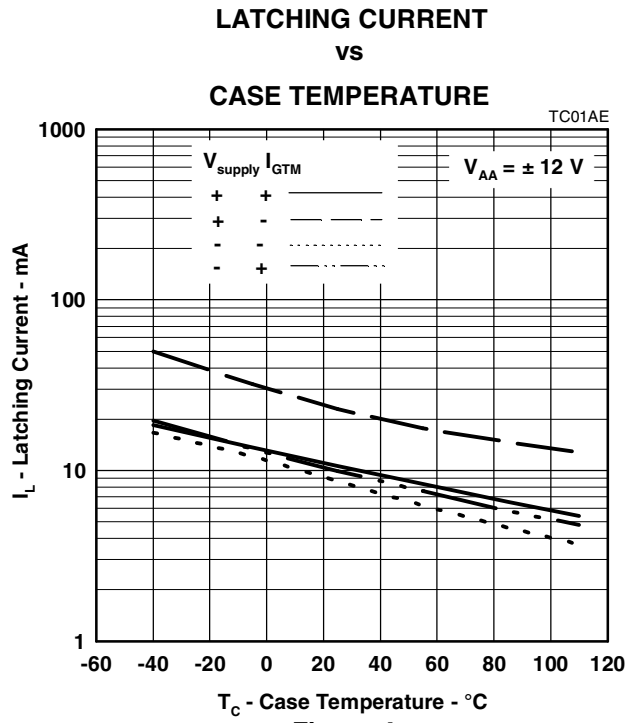

Figure 4.

THERMAL INFORMATION

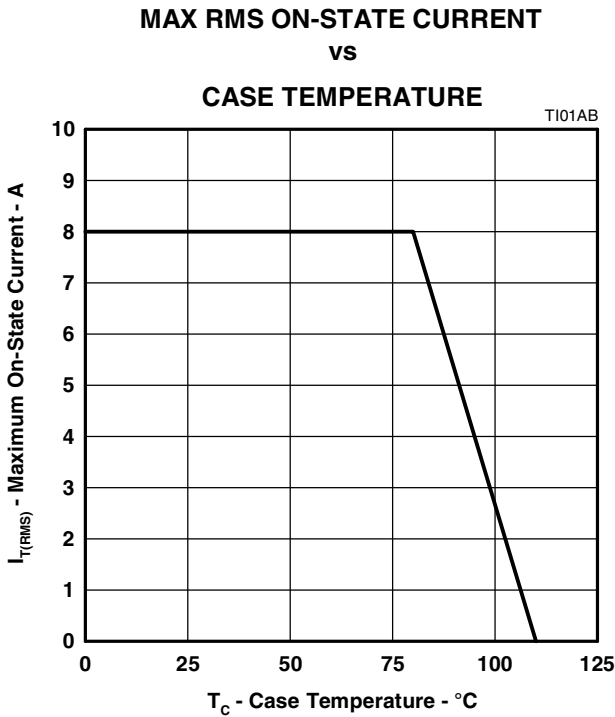

Figure 5.

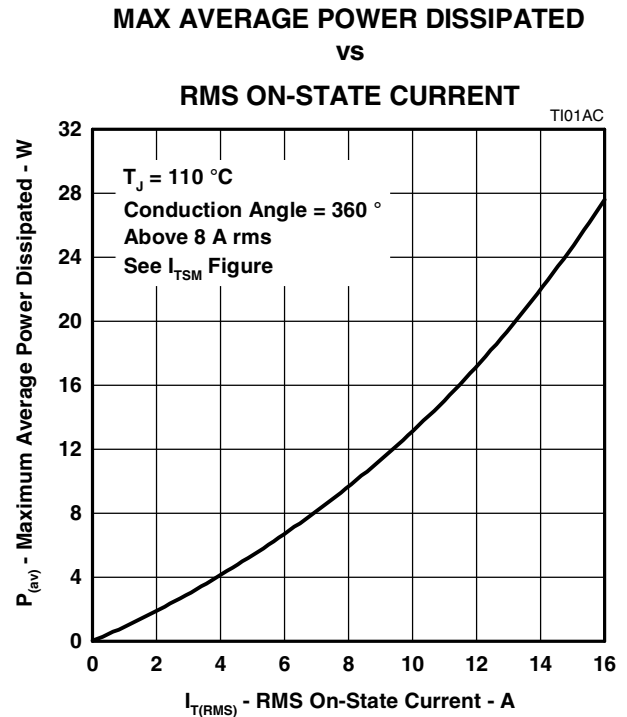
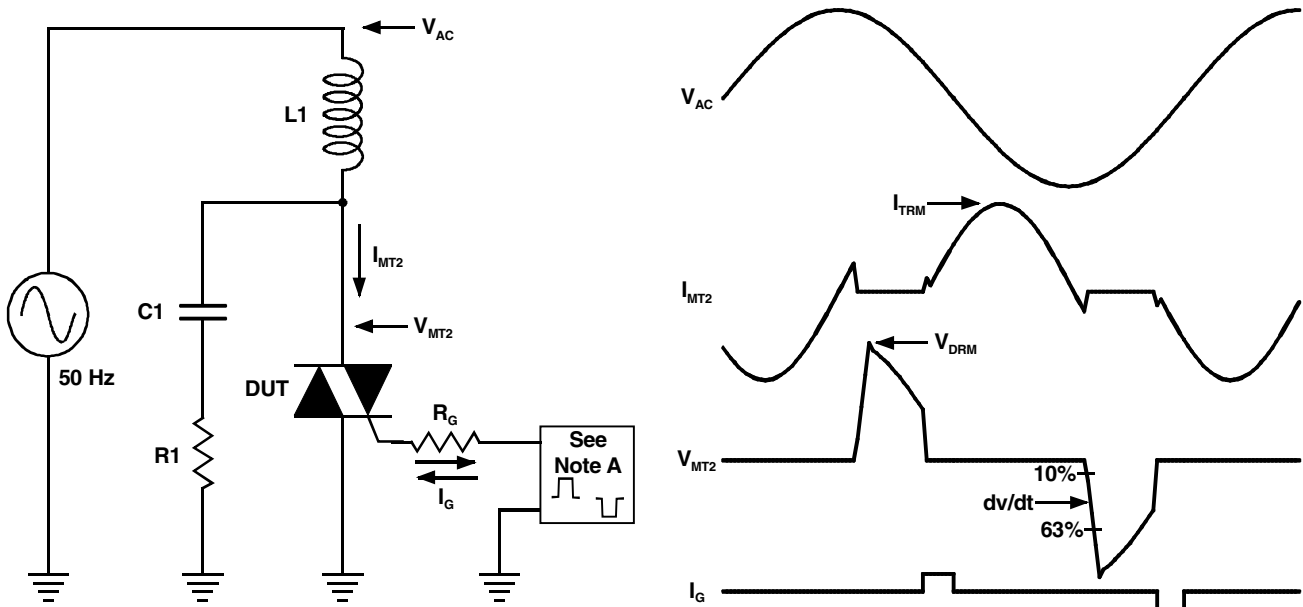

Figure 6.

PRODUCT INFORMATION

PARAMETER MEASUREMENT INFORMATION



NOTE A: The gate-current pulse is furnished by a trigger circuit which presents essentially an open circuit between pulses. The pulse is timed so that the off-state-voltage duration is approximately 800 μ s.

PMC2AA

Figure 7.